

Sepro S5-25 SPEED

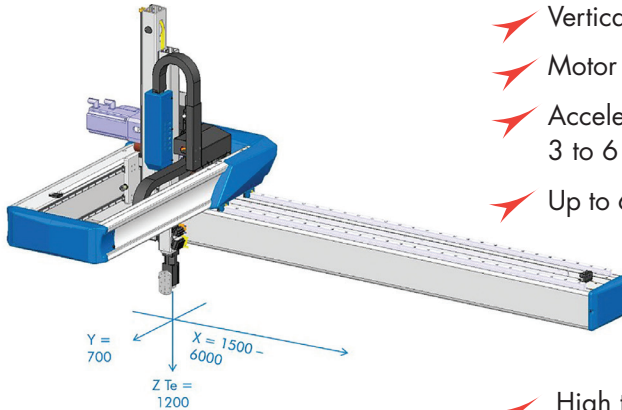

- Vertical arm optimized for speed
- Motor on vertical arm resized
- Acceleration Z upgraded from 3 to 6 g (vs S5-25 std)
- Up to 6m / sec on the vertical axis

- High torque
- Light design
- Simple R1 pneumatic

3-AXIS SERVO

Visual 2

IMMs	from 100 to 450 T
Application: Thin wall packaging with overall cycle time/overall cycle time	≤ 4 s
Horizontal stroke:	1500
Demold stroke:	700
Vertical stroke (telescopic):	1200
Wrist rotation: R1 [C] = 0-90° - Pneumatic	✓
Maximum load:	7 kg

Contact us:
sepro-group.com/contact

S5-25 Speed: performances

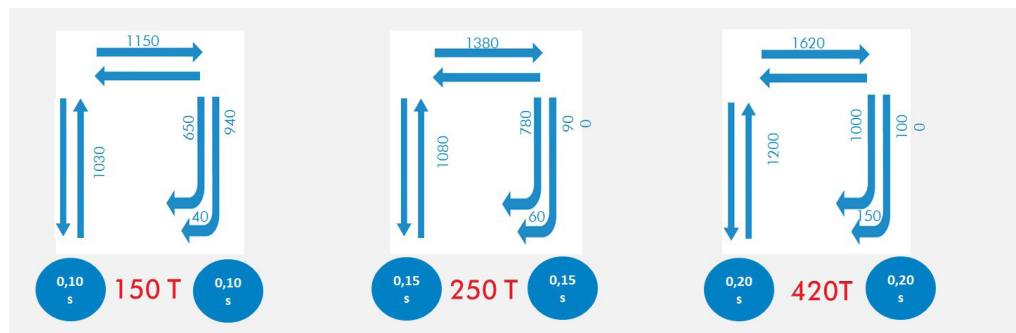

	150T	250T	420T
S5-25 TE standard			
Time in the press	1,23 sec	1,40 sec	1,58 sec
Total cycle time	4,93 sec	5,23 sec	5,66 sec
S5-15 Speed			
Time in the press	0,97 sec	1,16 sec	1,26 sec
Total cycle time	4,01 sec	4,31 sec	4,66 sec
S5-25 TE standard Speed 1200mm			
Time in the press	0,87 sec	1,04 sec	1,15 sec
Total cycle time	3,86 sec	4,18 sec	4,53 sec
S5-25 Speed compared to S5-25 TE standard			
In the press	29%	26%	27%
Total cycle	22%	20%	20%
S5-25 Speed compared to S5-15 Speed			
In the press	10%	10%	9%
Total cycle	4%	3%	3%